

TANITA

CONSUMER PRODUCT CATALOG 2022-2023



WORLD LEADING BIA Brand

Distributed by :
Kumala Home and Kitchen

 **KUMALA**
Home & Kitchen

www.tanita.asia

TANITA

Trusted by Professionals for Over 70 Years

Founded in 1944, TANITA is the worldwide leading brand of medical, commercial and consumer body fat monitors/scales. In 1992, TANITA introduced the World's First body fat scale for personal use. Over the years, TANITA's accuracy, innovation and excellent product quality have set a golden standard for Bio-electrical Impedance Analysis (BIA) monitors and are well trusted by physicians, clinicians and health & fitness experts worldwide. TANITA aims to develop unique health management solution in all-rounded aspects that enable people to enjoy fuller and healthier lives.



All-rounded Healthy Habits for Happiness



Professional BIA Technology

- Base on Bio-Electrical Impedance Analysis (BIA) to estimate the amount of body fat, muscle and other readings
- Send electrical signal throughout the body via metal footplates (and through handgrips for segmental monitors)
- Passes freely through blood, water and fluid within muscle tissue, but meets resistance when contacting with body fat
- Accurately measure body composition readings with reference to a scientific equation reference to users' gender, height and other information

Accurate and Quality Assurance

- At least four footplates are required for body composition monitor to ensure maximum accuracy of body composition readings
- Incorporate sound independent medical research spanning 25 years with 100,000 people worldwide in its studies, to ensure maximum accuracy of readings
- Estimate results based on electrical impedance at 50kHz frequency, which is the most reliable frequency referenced to DEXA
- Consumer products are certified by Japan JIS standard

TANITA HealthPlanet app

- Instantly record your results and track your progress.
- Easy-to-read charts and graphs for monitoring physical changes and body changes across different period of time.
- Set your own targets and achieve your peak performance.

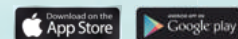

Visualize your body composition for better motivation and insights

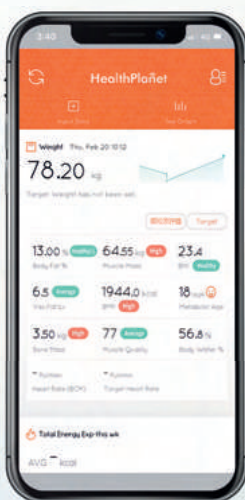

Overview

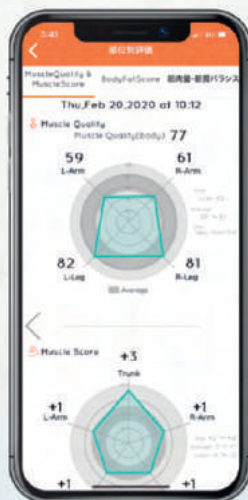

Segmental Muscle / Body Fat Readings (available for RD-545)

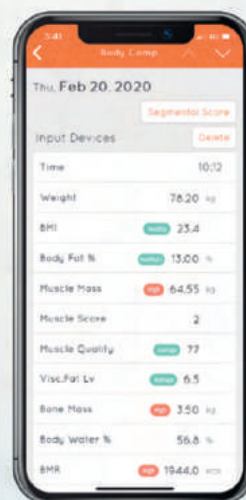

Detailed list of body composition reading

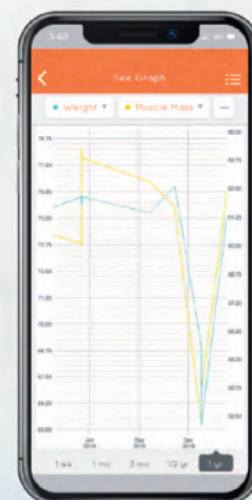

Graphs showing the body composition trend

TANITA

Body Composition Measurements



Body Fat Ranges (Adults and Children)

Body Fat % is the amount of fat as a proportion of body weight. Body fat is vital to basic bodily functions such as regulating body temperature, storing vitamins and cushioning joints. Yet, too much fat can damage your health. The indicator shows if the amount of body fat falls in the Underfat, Healthy, Overfat or Obese categories.



Basal Metabolic Rate (BMR)

Basal Metabolic Rate (BMR) is the daily minimum level of energy or calories you need at rest for your body to function effectively. A person at rest with a high BMR can burn more calories than person with a low BMR.



Total Body Water %

Total Body Water % is the total amount of fluid in the body expressed as a percentage of total body weight. Being well hydrated is important to support you to have good sports performance and well-being.



Metabolic Age

Metabolic Age indicates what age level the user's metabolism is associated with.



Muscle Quality Score

Muscle Quality Score indicates the condition (quality) of muscle which changes according to factors like age and exercise level. The score is rated at a full score of 100 and classified into 3 categories: High, Average and Low.



Muscle Mass

The weight of muscle in your body. Muscle plays an important role because they act as the body's engine in consuming energy (calories). As you exercise more, your muscle builds up, which in turn means increasing ability to burn more calories.



Daily Calories Intake (DCI)

Daily Calories Intake automatically calculates the number of calories an individual should consume within 24 hours in order to maintain their current weight.



Visceral Fat Rating

This rating indicates the level of internal fat in the abdomen that is scientifically proved to increase the risk of diabetes, hypertension and other metabolic syndromes. It is shown in a rating of 1 to 59.



Physique Rating

Physique Rating is an assessment of your physique according to the ratio of body fat and muscle mass in your body. With increasing activity level, weight may not change but the ratio of body fat and muscle may alter, which will change the user's overall physique.

Fat	Muscle Mass		
	-	○	+
Obese			
Over Fat	Hidden obese	Obese	Solidly-Build
Healthy	Under Exercised	Standard	Standard Muscular
Under Fat	Thin	Thin and Muscular	Very Muscular

Physique Rating will be displayed in a range of 1-9 as showing in the following graph:

$$\text{Index of amount of muscle against height} = \frac{\text{muscles mass (kg)}}{\text{height (cm}^2\text{)}}$$



Athlete Mode

TANITA body composition monitors incorporate the Athlete Mode for anyone who has carried out more than 12 hours of intensive aerobic exercise a week for at least 6 months and has a resting heartbeat of under 60bpm. It also applies to people who have a lifetime history of fitness - who used to do more than 12 hours exercise a week but do less now, still classified to athlete type.



Bone Mass

Bone Mass is the weight of bone mineral (including calcium or other minerals) in your body. It is useful to monitor and check for significant changes over time.

*TANITA's body composition monitors do not measure bone density. Please consult a physician if you are concerned about osteoporosis.



Segmental Measurements

With the 8-electrode segmental technology, monitors show individual's body composition measurements for each arm, leg and trunk area. Essential for the dedicated sports person to assess the impact of their training routine on their bodies.

13



FitPLUS feature for Women

After user keys in the start day of her menstrual cycle, the feature will hint her about different phases of the cycle to help maximize calories burnt and minimize fatigue.

Red light : Relaxation days

Amber light : Ovulation

Green light : Optimal active days



MBA Judgment

The MBA (My Body Analyzer) judgment is an evaluation based on your muscle condition, muscle fibers properties and muscle balance. This score benchmark your body ability by comparing with our 1,000+ professional athlete database.



Dual Technology

Professional Dual Frequency

- TANITA RD-series features the pioneering medical grade **Dual Frequency BIA Technology**
- Using two different bio electrical impedance frequencies provides essential data of a person's intra cellular and extra cellular status
- Provides comprehensive and precise body composition results as well as one's muscle condition – **"Muscle Quality"**

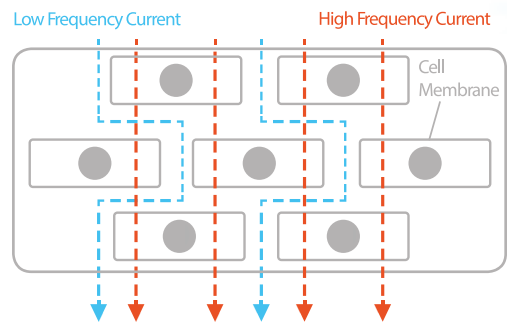

Muscle Quality Score

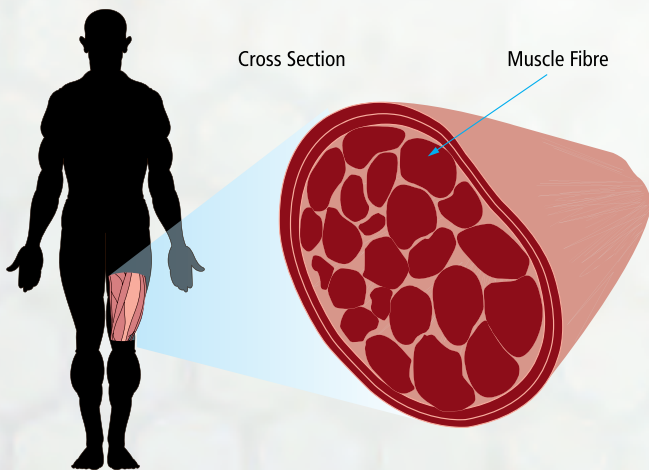

Muscle Strength is mainly related to Muscle Mass and Muscle Quality. Both aging and exercise level would change the muscle condition, i.e. the Muscle Quality.

Monitoring this Score can give you valuable insights on how to customize your training program to boost performance and avoid injuries.

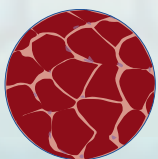

Muscle Quality is

HIGHER

Higher density of muscle fibre with little fat, water and connective tissue, etc.



Maintain regular exercise to ensure your Muscle Quality stays within the healthy

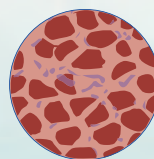

Muscle Quality is

LOWER

Muscle fibre is thinner and fewer as compared with other substances.



Increase exercise on a regular basis to improve your Muscle Quality.

RD-953



Dual Technology



Operation Video



Dual Frequency Body Composition Monitor for Smartphones

- Dual frequency technology allows comprehensive body composition readings
- Quick data connection to free mobile app, allows you to review & track your body composition level anytime and anywhere
- 200kg max weight capacity with 50g graduation

Technical Specifications

Max. Capacity/ Graduation	0 - 100 kg / 0.05 kg 100 - 200 kg / 0.1 kg
Product Size (mm)	298 x 328 x 32mm
Product Weight	2.1kg
Batteries	AA x 4
No. of User memories	4
Display Language	English
Color Option	Black, White, Red, Grey
Device Connection	Bluetooth

Packaging Information

Gift Box Size	359 x 379 x 49mm
Carton Size	265 x 391 x 377mm
Carton Quantity	5pcs / carton
Carton Weight	14.3kg

Body Composition Measurements:

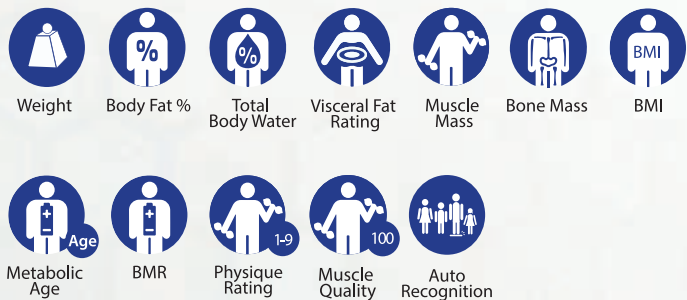

BC-402



RD series

BC series

HD series

HA series

Fitness Items

Others



Body Composition Monitor for Smartphones

- Apps to keep track your body changes
- Easy-to-clean glass platform and modern design to fit all homes
- One scale to store up to 5 family members data



Technical Specifications	
Max. Capacity/ Graduation	150kg/ 0.1kg
Product Size (mm)	217 x 316 x 27mm
Product Weight	1.5kg
Batteries	AAA x 4
No. of User memories	5
Display Language	English
Color Option	Black, White
Device Connection	Bluetooth
Supported OS	iOS 10 or later, Android 5.1 later

Packaging Information	
Gift Box Size	261 x 356 x 43mm
Carton Size	233 x 368 x 278mm
Carton Quantity	5pcs / carton
Carton Weight	9.5kg

Operation Video



Body Composition Measurements:

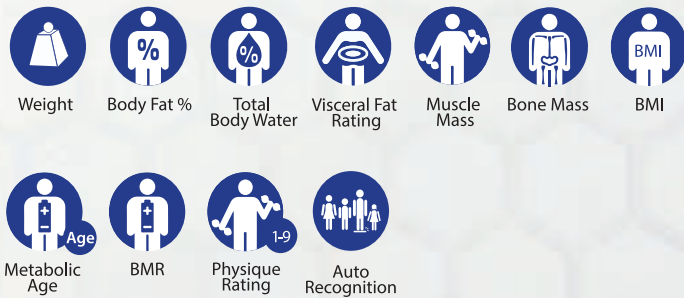

BC-545N



Operation Video



Segmental Body Composition Monitor with Easy-To-Read Analytical Graphic Display

- High resolution color display including newly improved easy-to-read analytical graphics
- Measurement tracking on a weekly, fortnightly and annual basis, allows you to review your fitness progress instantly
- Segmental readings for fat and muscle displayed in 9 levels, easy to assess the distribution of different parts and corresponding weight in one glance

Technical Specifications	
Max. Capacity / Graduation	150kg/0.1kg
Product Size (mm)	320 x 384 x 57mm
Product Weight	2.5kg
Batteries	AA x 4
No. of User memories	5
Display Language	English

Packaging Information	
Gift Box Size	378 x 454 x 69mm
Carton Size	465 x 298 x 398mm
Carton Quantity	4pcs/ carton
Carton Weight	14.4kg

Body Composition Measurements:

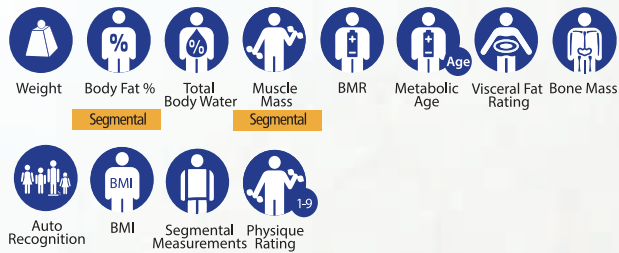

BC-730



Compact and Lightweight Body Composition Monitor

- 880g lightweight and compact

Technical Specifications	
Max. Capacity / Graduation	150kg/ 0.1kg
Product Size (mm)	216 x 260 x 33m
Product Weight	880g
Batteries	AA x 4
No. of User memories	5
Size of Display	21.3mm
Display Language	English
Color Options	Pink, Green, White

Packaging Information	
Gift Box Size	253 x 300 x 44mm
Carton Size	316 x 288 x 274mm
Carton Quantity	6pcs/ carton
Carton Weight	7.2kg

Body Composition Measurements:

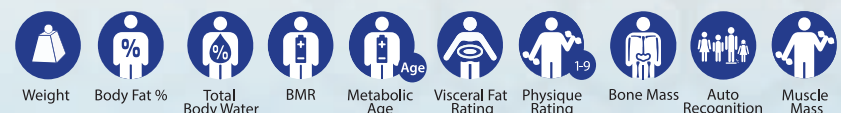

BC-G02



Lightweight Body Composition Monitor with FitPlus Feature

- Equipped with target weight setting and FitPlus feature, perfect companion for female
- The monitor will notify the user if there is a significant change in her body weight

Technical Specifications	
Max. Capacity / Graduation	150kg/ 0.1kg
Product Size (mm)	226 x 266 x 34mm
Product Weight	0.9kg
Batteries	AA x 4
No. of User memories	2
Size of Display	21.3mm
Display Language	English
Color Option	White, Lime Green, Pink

Packaging Information	
Gift Box Size	292 x 300 x 56mm
Carton Size	270 x 330 x 320mm
Carton Quantity	4pcs/ carton
Carton Weight	8.3kg

Body Composition Measurements:

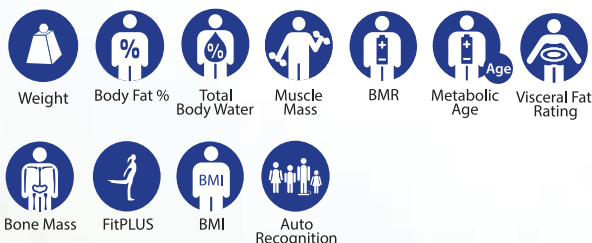

BC-541N



Lightweight Plastic Body Composition Monitor

- 30mm easy-to-read extra-large display
- Blue Backlit LCD Display

Technical Specifications	
Max. Capacity / Graduation	0 – 150kg/ 0.1 kg
Product Size (mm)	285 x 278 x 36 mm
Product Weight	1.2kg
Batteries	AA x 4
No. of User memories	5
Size of Display	30mm
Display Language	English
Color Option	Black, White

Packaging Information	
Gift Box Size	334 x 361 x 52mm
Carton Size	240 x 370 x 365mm
Carton Quantity	4pcs/ carton
Carton Weight	7kg



Body Composition Measurements:

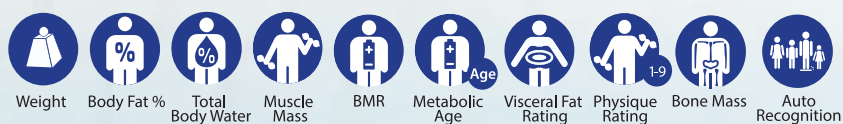

Operation Video



BC-543



Glass Body Composition Monitor with Touch Buttons

- Tempered Glass surface with easy-to-operate touch buttons

Technical Specifications	
Max. Capacity / Graduation	150kg/ 0.1kg
Product Size (mm)	320 x 300 x 44mm
Product Weight	2.4kg
Batteries	AA x 4
No. of User memories	4
Size of Display	32mm
Display Language	English

Packaging Information	
Gift Box Size	370 x 365 x 70mm
Carton Size	378 x 293 x 385mm
Carton Quantity	4pcs/ carton
Carton Weight	14.3kg

Body Composition Measurements:

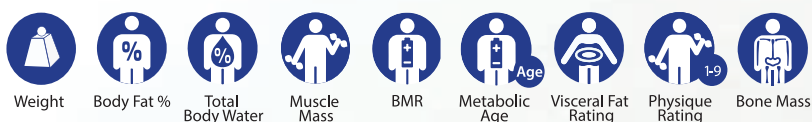

BC-541



Plastic Body Composition Monitor with Touch Buttons

- Durable grey plastic platform
- Easy-to-operate touch buttons

Technical Specifications	
Max. Capacity / Graduation	150kg / 0.1kg
Product Size (mm)	302 x 307 x 43.2mm
Product Weight	2.4kg
Batteries	AA x 4
No. of User memories	4
Size of Display	32mm
Display Language	English

Packaging Information	
Gift Box Size	355 x 355 x 64mm
Carton Size	365 x 273 x 366mm
Carton Quantity	4pcs/ carton
Carton Weight	12.6kg

Body Composition Measurements:

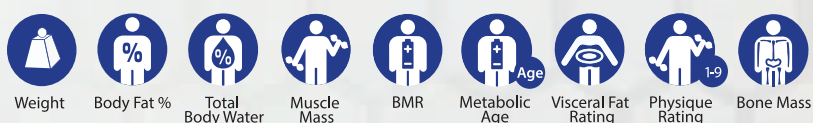

BC-587



High Capacity Glass Body Composition Monitor

- Features high weight capacity and extra wide platform
- Results are clearly displayed on an extra-large LCD screen with backlight

Technical Specifications

Max. Capacity / Graduation	200kg/ 0.1kg
Product Size (mm)	300 x 340 x 43mm
Product Weight	2.7kg
Batteries	AA x 4
No. of User memories	4
Size of Display	32mm
Display Language	English

Packaging Information

Gift Box Size	374 x 390 x 68mm
Carton Size	306 x 410 x 390mm
Carton Quantity	4pcs/ carton
Carton Weight	14kg

Body Composition Measurements:



HD-378



Technical Specifications

Max. Capacity/ Graduation	150kg / 0,1kg
Product Size (mm)	320 x 300 x 20mm
Product Weight	2kg
Batteries	Lithium Battery x1

Packaging Information

Gift Box Size	335 x 310 x 30mm
Carton Size	350 x 200 x 330mm
Carton Quantity	6pcs/ carton
Carton Weight	7kg

HA-552



BMI reading appears immediately after stepping on the scale

- Choose your height before you step onto the scale. Your BMI health range will automatically display together with your weight

Technical Specifications

Max. Capacity/ Graduation	120kg/ 0.5kg
Product Size (mm)	240 x 280 x 65mm
Product Weight	1.6kg

Packaging Information

Gift Box Size	244 x 293 x 72mm
Carton Size	305 x 446 x 266mm
Carton Quantity	6pcs/ carton
Carton Weight	11.1kg

HD-394



Digital Bathroom Scale with Large Red LED Display

Technical Specifications

Max. Capacity/ Graduation	150kg/ 0.1kg
Product Size (mm)	250 x 310 x 32mm
Product Weight	0.84kg
Batteries	AAA x 4
Size of Display	34mm
Display Language	English
Color Option	Wine Red, Black, White, Pink

Packaging Information

Gift Box Size	286 x 351 x 40mm
Carton Size	260 x 363 x 305mm
Carton Quantity	6pcs/ carton
Carton Weight	7kg

TANITA

The global leader in
precision weighing and BIA body composition equipment

TANITA Corporation

Address: 14-2, 1-Chome, Maeno-cho, Itabashi-ku, Tokyo, JAPAN 174-8630
Tel: +81-3-3968-7048
Fax: +81-3-3968-2661
Email: info@tanita.co.jp
Website: www.tanita.co.jp

TANITA Health Equipment H.K. Ltd

Address: Unit 301-303, 3/F, Wing On Plaza, 62 Mody Road, Tsimshatsui East, Kowloon, HONG KONG
Tel: +852-2834-3917
Fax: +852-2838-8667
Email: asia-pacific@tanita.co.jp
Website: www.tanita.asia

TANITA Europe B.V.

Address: Hoogoorddreef 56E, 1101 BE Amsterdam, THE NETHERLANDS
Tel: +31-20-560-29-70
Fax: +31-20-560-29-88
Email: info@tanita.eu
Website: www.tanita.eu

TANITA Corporation of America, Inc.

Address: 2625 South Clearbrook Drive, Arlington Heights, IL 60005, USA
Tel: +1-847-640-9241
Fax: +1-847-640-9261
Email: 4health@tanita.com
Website: www.tanita.com

TANITA (Shanghai) Trading Co. Ltd.

Address: Room 8005, 887 Huai Hai Zhong Lu, Shanghai, CHINA
Tel: +86-21-6474-6803
Fax: +86-21-6474-7901
Email: info@tanita.com.cn
Website: www.tanita.com.cn

Disclaimer:

TANITA reserved all rights including data integrity of information in this brochure. Shall any parties are interested in the products, please contact TANITA Asia Pacific Regional Sales Office formore information.

TANITA Asia Pacific © Aug 2021 version

Detailed Product Comparison:
Please browse our website

Sole Distributor :
P.T. Kumala Kencana Cipta
Jl. Dr Susilo IV No 11A
Jakarta Barat 11470
Indonesia

www.kumalahomeandkitchen.com

 [kumalahomeandkitchen](https://www.instagram.com/kumalahomeandkitchen)